

2020 N1008

20 Mile Spray

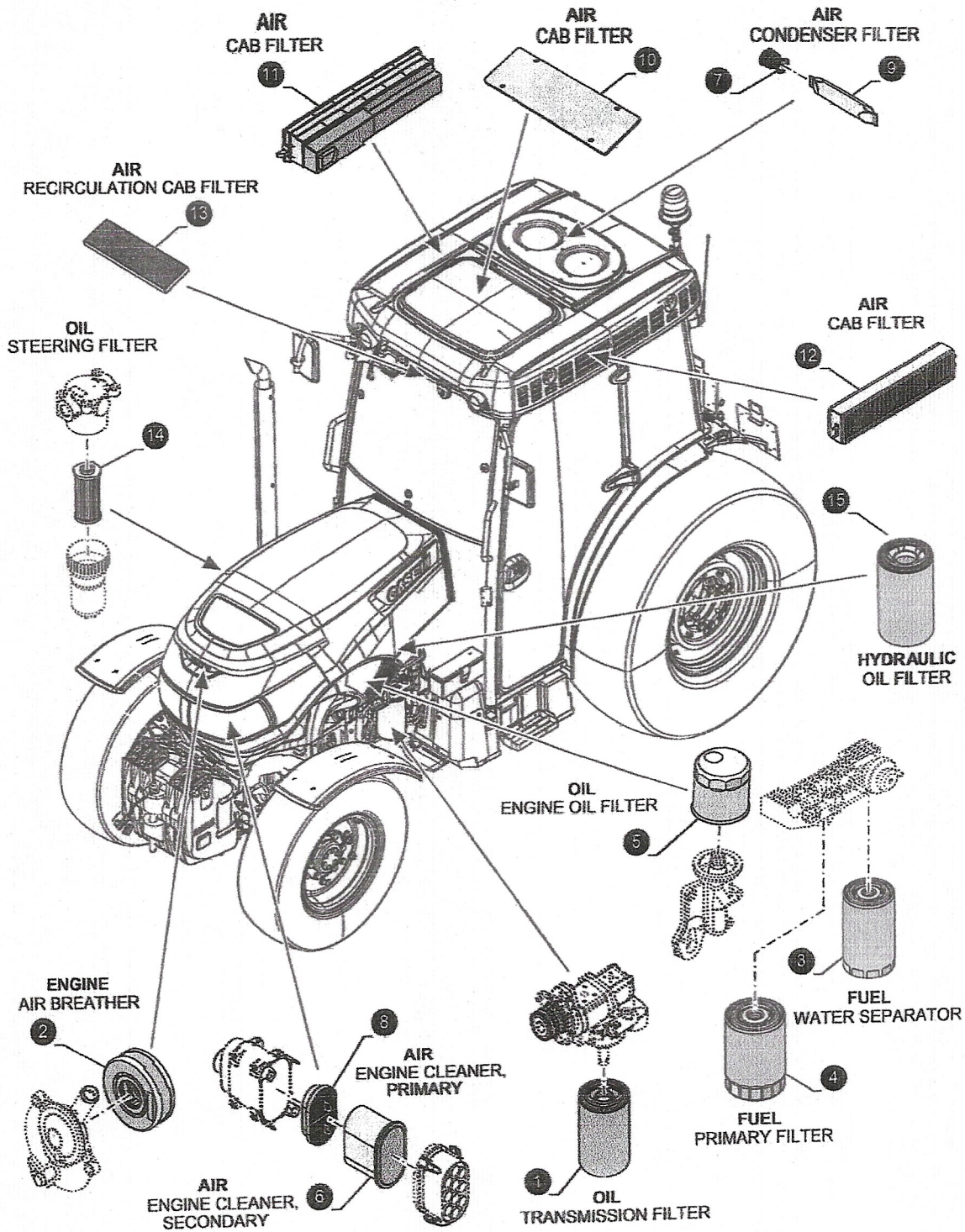











Serial Number: HLRF011NCLLU01054

Farmall N > Farmall 110n - Special Tractor - W/cab - Tier 4a - My18 Sep 2017 > 05 - Service & Maintenance > 05.100.041 - MAINTENANCE PARTS - FILTERS



Serial Number: HLRF011NCLLU01054

Farmall N > Farmall 110n - Special Tractor - W/cab - Tier 4a - My18 Sep 2017 > 05 - Service & Maintenance > 05.100.041 - MAINTENANCE PARTS - FILTERS

indicators	Ref	Qty	PN	Description	Usage
←	1	1	84581942	HYDRAULIC OIL FILTER 135mm OD x 244mm L, M55 x 1.5, 50 Microns	HYDRAULIC OIL FILTER - 135mm OD x 244mm L, M55 x 1.5, 50 Microns; Every 300 Hours
←	2	1	580168648 4	FILTER, ENGINE BLOW BY BREATHER	FILTER, ENGINE BLOW BY - BREATHER; Breather, on Engine
←   	3	1	47450038	FUEL FILTER 97mm OD x 185.5mm L, M16 x 1.5	FUEL FILTER - 97mm OD x 185.5mm L, M16 x 1.5; Fuel Filter, on Engine, Every 600 Hours
← 	4	1	47450037	FUEL FILTER 109mm OD x 173mm L, M16 x 1.5	FUEL FILTER - 109mm OD x 173mm L, M16 x 1.5; Fuel Filter, on Engine, Every 600 Hours
←    	5	1	47535939	ENGINE OIL FILTER 97.5mm OD x 92mm L, M27 x 2, 30 Micron	ENGINE OIL FILTER - 97.5mm OD x 92mm L, M27 x 2, 30 Micron; Every 600 Hours
←  	6	1	87037984	AIR FILTER 216mm ID x 251,4mm OD x 175mm L	AIR FILTER - 216mm ID x 251,4mm OD x 175mm L; Secondary, Engine Air Cleaner, Every 1200 Hours or Annually
← 	8	1	87037985	AIR FILTER 209,3mm L	AIR FILTER - 209,3mm L; Primary, Engine Air Cleaner, Every 1200 Hours or Annually
	14	1	48195967	HYDRAULIC OIL FILTER	HYDRAULIC OIL FILTER; Hydraulic Oil, Transmission/ Steering; (Prod Date) From 04- Dec-2019
← 	14	1	5194879	HYDRAULIC OIL FILTER	HYDRAULIC OIL FILTER; Hydraulic Oil, Transmission/ Steering; (Prod Date) Up to 03- Dec-2019